



joy
playgrounds



j101

j102

j201

j202

j203

j204

j205

j206

j207

j301

j401

j402

j501

j601

j701



joy

Studio Kuadra

j204, j205, j206
playgrounds

671

Disponibile nei seguenti materiali e dimensioni:
Available in the following materials and sizes:
Disponibile dans les dimensions et matériaux suivants:
Disponibile en los siguientes materiales y tamaños:
Disponível nos seguintes materiais e tamanhos:
Erhältlich in den folgenden Materialien und Größen:



Acciaio Zincato e Verniciato / Galvanized and Powder Coated Steel
Acier Galvanisé et Thermolaqué / Acero Galvanizado y Barnizado
Aço Galvanizado e Pintado / Stahl, Verzinkt und Pulverbeschichtet



Alluminio Verniciato / Powder Coated Aluminum
Aluminium Thermolaqué / Aluminium Pintado
Alumínio Pintado / Aluminium, Pulverbeschichtet



Acciaio Inox / Stainless Steel
Acier Inox / Acero Inox
Aço Inox / Edelstahl



Polietilene ad alta densità / High Density Polyethylene
Polyéthylène Haute Densité / Polietileno de Alta Densidad
Polietileno de Alta Densidade / Polyethylen Hoher Dichte

Vedi disegni a pag.: / See drawings on page:
Voir plans page: / Veá los dibujos de la pág.:
Veja os desenhos em p.: / Siehe Zeichnungen auf Seite:
733

Fissaggio: / Fixings: / Fixation: / Fijación: / Fixação: / Befestigung:
Predisposizione per tasselli, cementazione
Pre-drilled for bolts, below ground installation
Réservation cheville, scellement
Predisposición para tacos, cimentación
Preparação para buchas, cimentação
Mit Bohrungen für Verschraubung, Zementierung

j 101

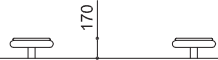

j 102

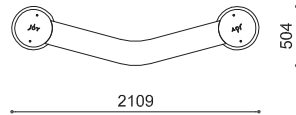

j 201

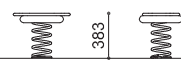

j 202

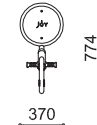
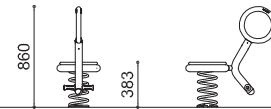

j 205

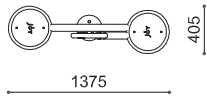
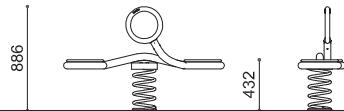

j 203

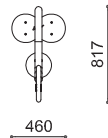
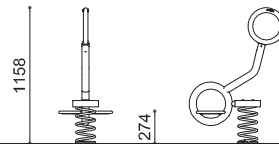

j 204

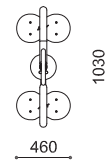
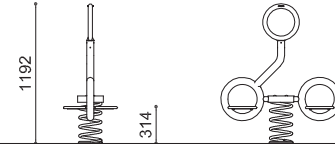

j 207

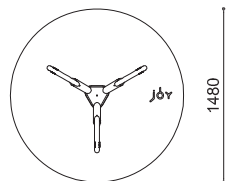
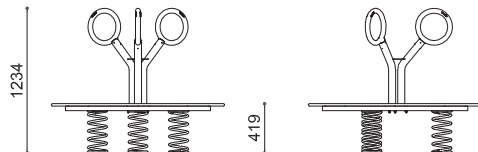

j 206

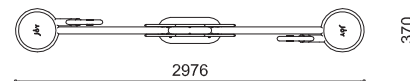
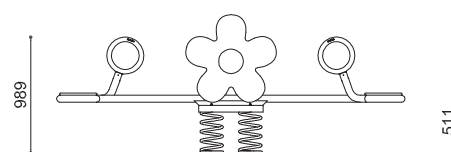

j 301

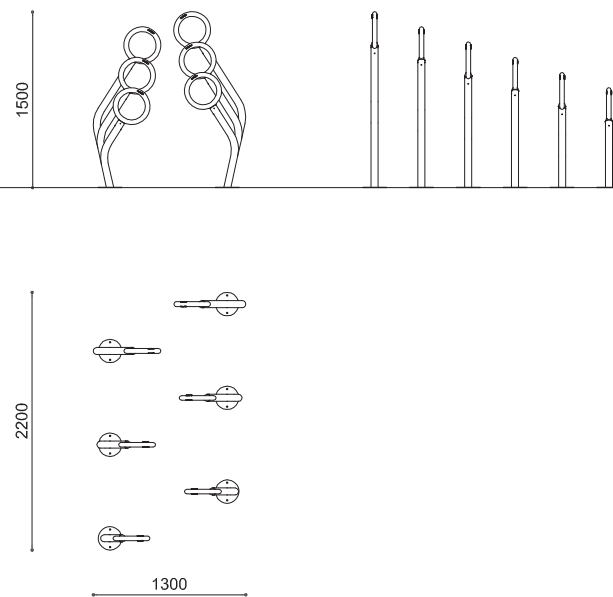

j 601

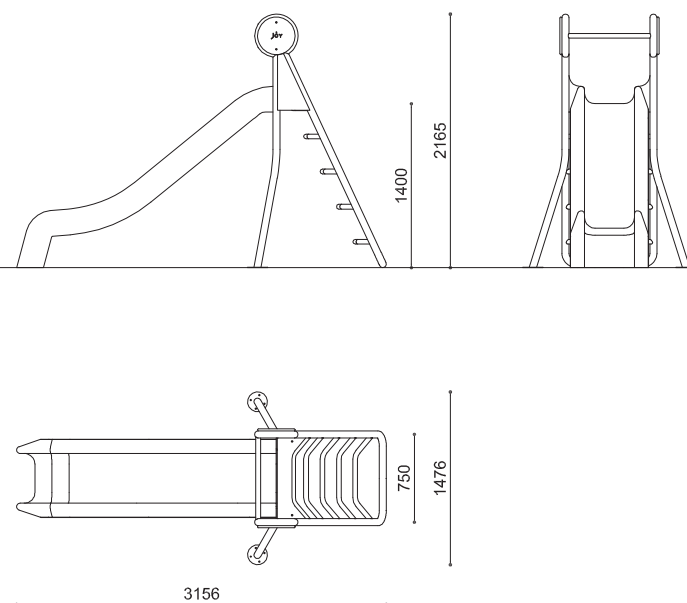

j 701

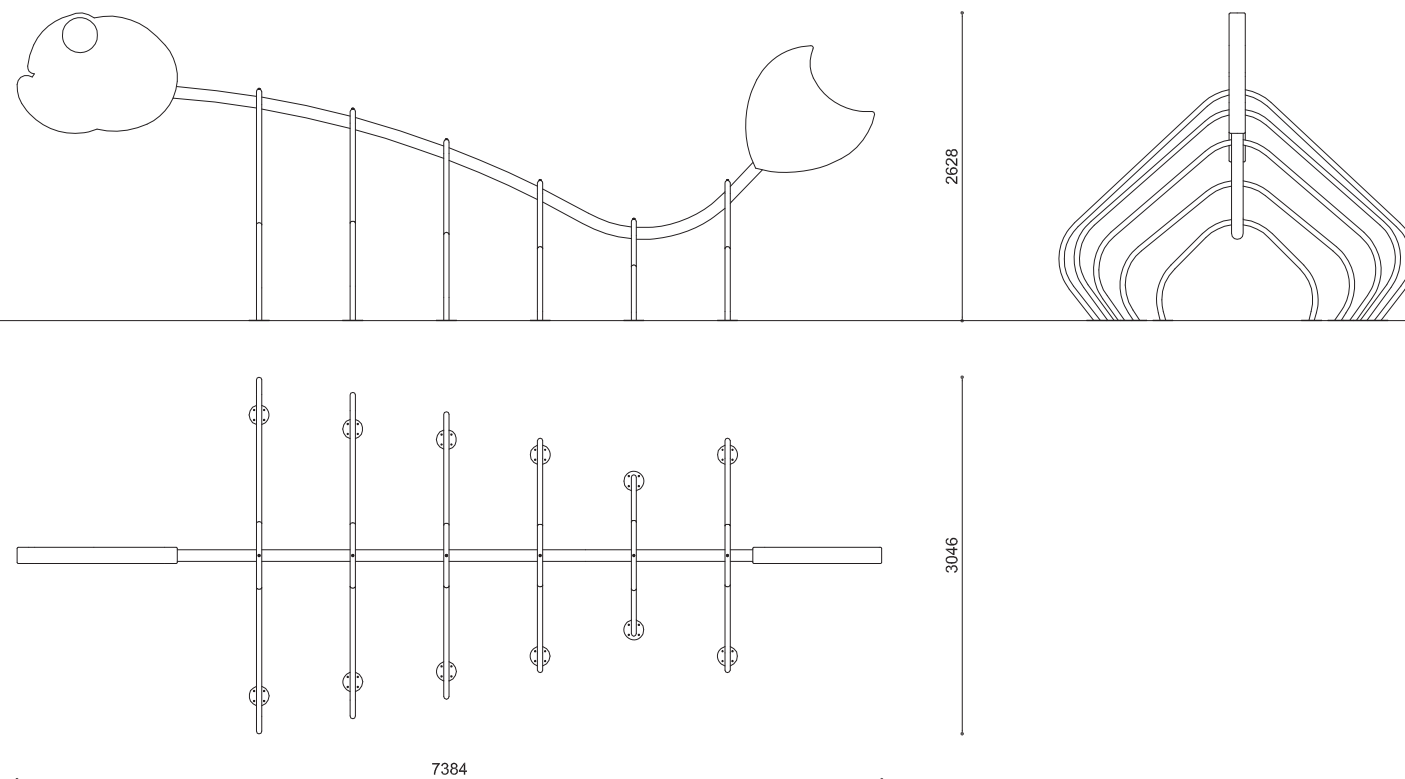

734

j 501

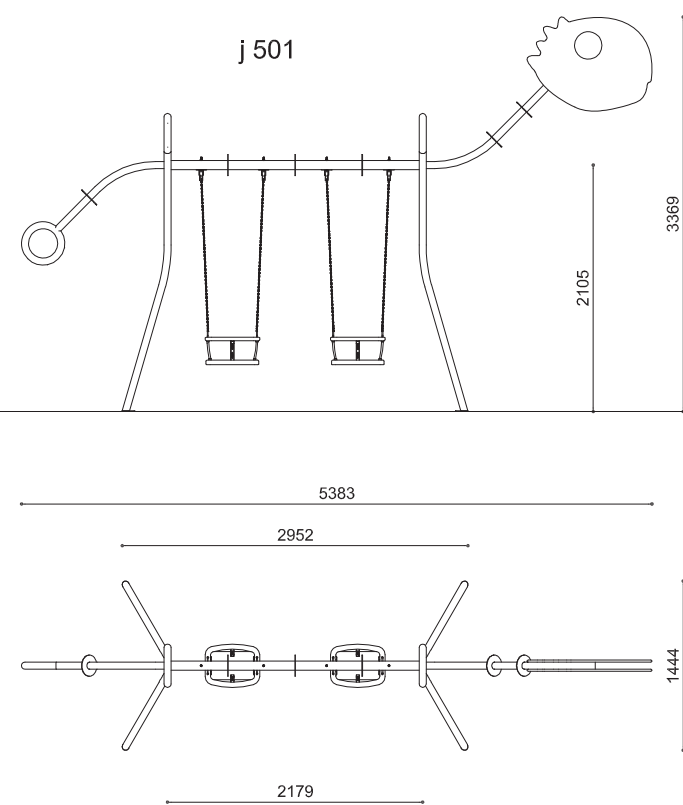

j 401

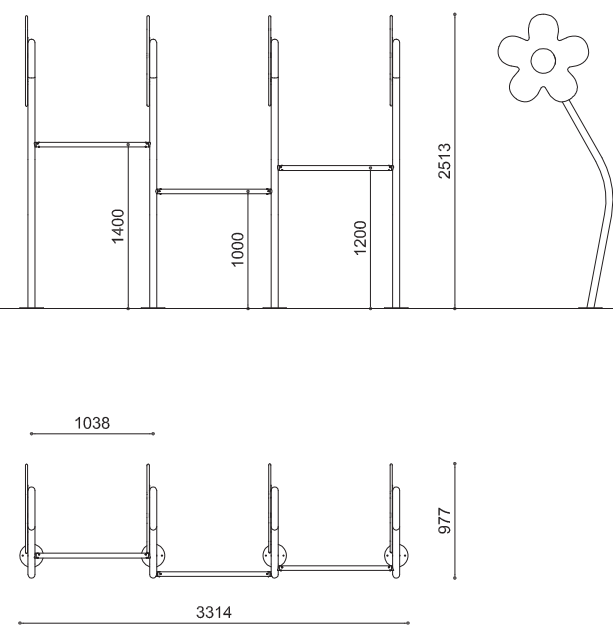

j 402

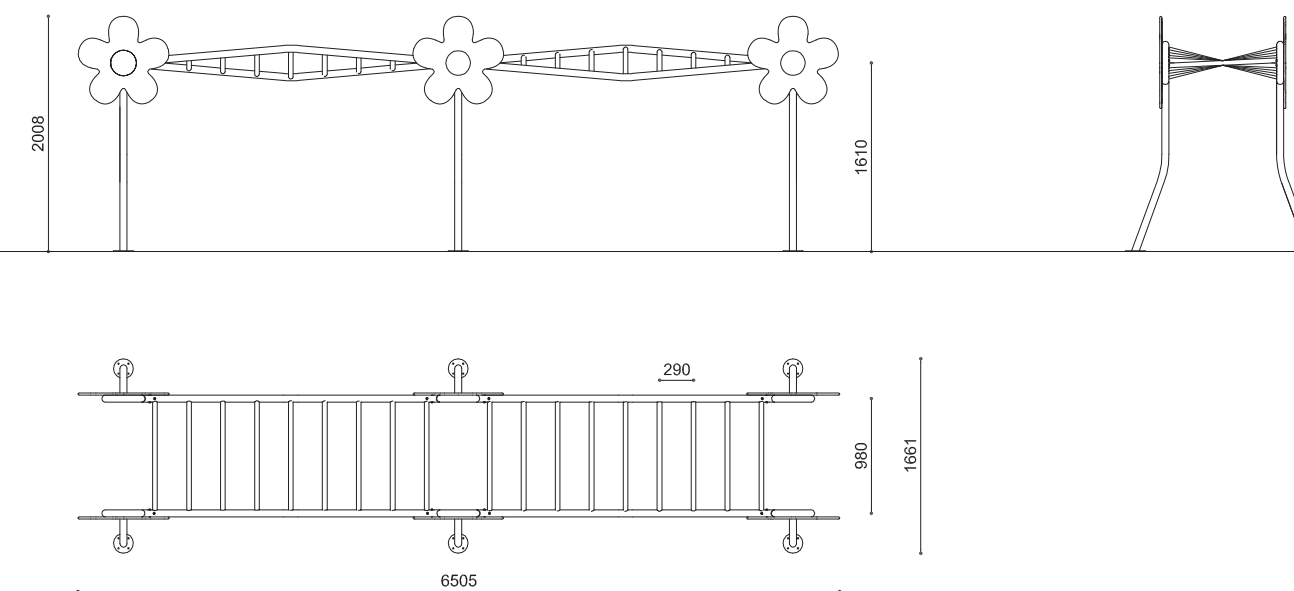

735